



User's Manual

XC-RF850 Reader

Thank you for using Invengo's RFID products!

We are glad that you've chosen XC-RF850 UHF RFID reader.

We hope our product will make your daily tasks at work easier!



Foreword

This user manual is intended for using with XC-RF850 FCJ/FCW/FLJ/FLW

This manual provides information on product application, maintenance, repair and other features for users and maintenance staff of the products.

The version of this manual is V1.1, with revision record as follows:

19th Jan 2015	Initial draft	V1.0
7th Dec 2017	Corrections	V1.1

 or  **Invengo** are Invengo's trademarks.

All introduction and explanation on the product features, as well as the functions and other related information, written in this manual, are the latest and accurate as at time of print.

The company reserves all rights to make any correction or amendment to this manual without prior notice, and shall bear no responsibility for these actions.

Main content

Product Overview

Reader Installation and Commissioning

DEMO User Guide

Routine maintenance and service

Transportation and storage

Packaging and Inspection

After-sale service

Safety Instructions



Warning sign

Improper handling may cause damage to health.

Improper handling may result in equipment damage.



Notification sign

If ignored, it may result in unsuccessful operation.

If ignored, it may result in undesired effect.

Content

1 Product Overview	1
1.1 Brief introduction	1
1.2 Main usage and application range	1
1.3 Product certificate	2
1.4 Applicable regions and frequency bands	3
1.5 Operation condition	3
1.6 Safety and protective measures	3
1.7 Main functions	4
1.8 Technical parameters	4
1.9 Dimensions	5
1.10 Weight	5
2 Reader installation and commissioning	6
2.1 Unboxing instruction	6
2.2 Installation requirement	6
2.3 Panel description	7
2.3.1 I/O and communication patch panel	7
2.3.2 RF connector panel	10
2.3.3 LED display panel	11
2.4 Commissioning preparation	11
2.4.1 Personal computer Require.....	11
2.4.2 Reader interface software	12
2.4.3 External antenna	12

2.5 Safety during installation	14
2.5.1 External RF cable.....	14
2.5.2 Power and communication interface cable	15
2.5.3 I/O control port cable.....	17
2.6 Equipment installation.....	19
2.7 Common scenario during commissioning	24
2.8 Inspection and acceptance	25
3 DEMO user guide.....	26
3.1 Preparation and examination.....	26
3.2 Demo software	26
3.2.1 Demo software installation	26
3.3 Demo software operation	31
3.3.1 Demo initialization	31
3.3.2 Connection	31
3.3.3 Reader configuration.....	33
3.3.4 Antenna choice.....	34
3.3.5 Scanning configuration	34
3.3.6 Tag operation	35
3.3.8 GPIO	36
3.3.9 Operation mode.....	38
3.3.10 Version Enquiry	39
4 Routine maintenance and service	40
4.1 Routine maintenance.....	40
4.2 Troubleshooting and solution.....	40
5 Transportation and storage	43
5.1 Transport requirements.....	43

5.2 Storage requirements	43
6 Packaging and Inspection	44
6.1 Packaging	44
6.2 Inspection	44
7 After-sales service.....	46
7.1 Other matters.....	46

1 Product Overview

1.1 Brief introduction

XC-RF850 is a high performance UHF RFID reader. It is compatible with ISO18000-6C protocol, has operating frequency between 902.75MHz - 927.25MHz, excellent security and performance. The reader also has a sleek design and is very easy to install.



Figure 1-1 XC-RF850 reader

XC-RF850 reader is compatible with the tag under ISO18000-6C protocol standards, capable of conducting wireless communication with the tag through antenna, and perform reading and writing operation on tag ID code and memory data.

1.2 Main usage and application range

XC-RF850 reader is a high performance UHF reader, compatible with the ISO18000-6C tags. In addition to a built-in circular polarization antenna or a built-in linear polarized antenna, the XC-RF850 reader provides one external antenna port, which allows cost-effective external antenna solutions.

Compared to similar products in the market, the XC-RF850 reader has the advantages of compact appearance, flexible installation, high protection level, and can meet the requirement of customer's dual antenna application.

XC-RF850 reader can meet a variety of application needs, especially in parking lot management and electronic toll collection.

1.3 Product certificate

FCC Certificate

TCB

**GRANT OF EQUIPMENT
AUTHORIZATION**

TCB

Certification
Issued Under the Authority of the
Federal Communications Commission
By:

Siemic Inc.
775 Montague Expressway
Milpitas, CA 95035

Date of Grant: 05/23/2014
Application Dated: 05/23/2014

Invengo Information Technology Co., Ltd.
3/F, NO. T2-B, High-Tech Industrial Park South,
Shenzhen,
China

Attention: Shuangliang Yi , Quality manager

NOT TRANSFERABLE

EQUIPMENT AUTHORIZATION is hereby issued to the named GRANTEE, and is VALID ONLY for the equipment identified hereon for use under the Commission's Rules and Regulations listed below.

FCC IDENTIFIER: TQ4XC-RF850
Name of Grantee: Invengo Information Technology Co., Ltd.
Equipment Class: Part 15 Spread Spectrum Transmitter
Notes: Reader

<u>Grant Notes</u>	<u>FCC Rule Parts</u>	<u>Frequency Range (MHZ)</u>	<u>Output Watts</u>	<u>Frequency Tolerance</u>	<u>Emission Designator</u>
	15C	902.75 - 927.25	0.514		

Power listed is the maximum conducted output power.

The antenna(s) used for this transmitter must be installed to provide a separation distance of at least 20 cm from all persons and must not be co-located or operating in conjunction with any other antenna or transmitter.

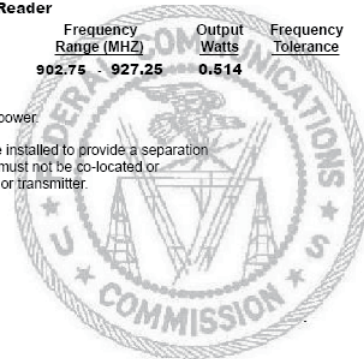

1.4 Applicable regions and frequency bands

North America's frequency band (US):

- 902.75MHz ~ 927.25MHz

Europe's frequency band (EU)

- 865.7MHz ~ 867.5MHz

1.5 Operation condition

- Operating temperature: -20°C to +70°C(Operating temperature for power adapter: 0°C ~ +40°C)
- Humidity range: 5% to 95%RH, no condensation
- Power supply: power adapter (standard)

The technical standard of power adapter is as follows:

- Product code: 1080200007
- AC input: 100 - 240V, 50 - 60Hz;
- DC output: 24V/2.5A
- Operating temperature: 0oC to +40oC
- Storage temperature: -20oC to +65oC

1.6 Safety and protective measures



When the product is in operation (radiated microwave power), installation and commission personnel should stay 20cm away from the antenna so as to meet the FCC maximum allowable frequency (RF) requirement for human exposure!



Any radio transmitting equipment, including this equipment, may cause interference with medical equipment that is not properly protected. If there is any problem in this regard, please consult with the medical equipment manufacturer. The operation of this equipment may also cause interference with other electronic devices!

1.7 Main functions

- EPC protocol: EPC C1G2 V1.1 mandatory command.
- One external antenna supported
- Tag data filter
- GPIO: two optocoupler input; three relay output or two Wiegand output.
- Maintenance support: remote maintenance and upgrade
- Over-current protection: support (automatically cut off the power supply current which is more than 3A)
- Air interface: EPC global UHF Class 1 Gen 2 and ISO / 18000-6C
- Operation mode: constant frequency hopping / optional
- Network protocol: DHCP, HTTP, and SSH
- Built-in antenna polarization: circularly or linearly polarized

1.8 Technical parameters

- Operating frequency: 902.75MHz ~ 927.25MHz, frequency spacing 500KHz; 865.7MHz ~ 867.5MHz, frequency spacing 600KHz
- RF power: 30dBm (Max output power)
- Read distance 0~6 meters (configuration dependant)
- Power supply: AC adapter: AC input 100-240V, 50-60Hz; DC output 24V \pm 1.5V/2.5A
- Network communication rate: 10M/100M Adaptive
- RS232 serial communication rate: 115200bps (the default), 19200 bps, 9600bps
- Wiegand output support: Wiegand 66, Wiegand 26 and Wiegand 34
- Built-in antenna VSWR: circular polarization \leq 1.4: 1 or linear polarization \leq 1.5: 1
- Built-in antenna gain: circular polarization (or polarization) \geq 7.15dBi
- IP rating: IP65

1.9 Dimensions

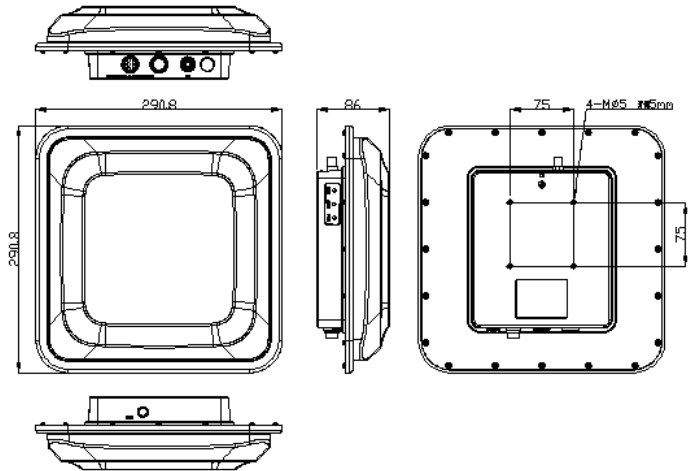

Figure 1-2 XC-RF850

The size of XC-RF850 reader is:

- Metric 290.8mm x290.8mm x 86mm(Not inclusive of accessories)
- Imperial 11.49 in x11.49 in x 3.38 in

1.10 Weight

The weight of XC-RF850 reader:

- Metric Approximately 1.0kg (Not inclusive of accessories)
- Imperial Approximately 4.40 lb

2 Reader installation and commissioning

2.1 Unboxing instruction

Aside from XC-RF850 reader, the package also includes the following items:

- 1) One power and communication cable
- 2) One external IO port cable
- 3) One 1.5m long RJ45 crossover cable
- 4) Cross recessed pan head, screws spring washer and flat washer assembly M5 × 10_ stainless steel _GB9074
- 5) Holding rod_XC-RF850
- 6) Small circular connector female flange socket protective cover 08-1080-000-000
- 7) Waterproof insulating tape J-20_20mm (W) × 0.8mm (T) _ entire roll thickness 85mm
- 8) One power adapter with a three-prong power code
- 9) CD-ROM, product certificate and product warranty (One each)

2.2 Installation requirement

Before the installation of XC-RF850 reader, please check thoroughly the items in the package according to the list of items. Should there be any discrepancy or damage, please contact the local supplier immediately for replacement. At the same time, please check if the following items fulfill the installation requirement:

- Compatible with the operating environment;
- Complete list of accessories that sufficient to fulfill the required standard and form a complete tag reading and writing environment.

2.3 Panel description

This section details the functions of various ports and LED indicator of the equipment.

2.3.1 I/O and communication patch panel

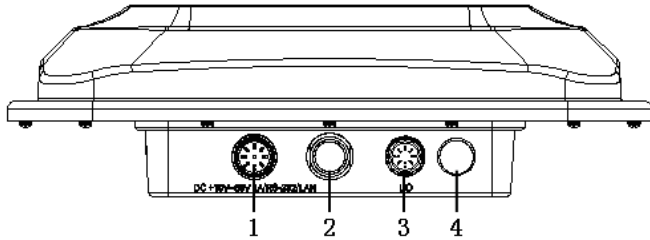

Figure 2-1 XC-RF850 reader's I/O and communication port panel

The description of each port:

- 1 - Power and Communication port
- 2 - Standby Interface
- 3 - I/O Control Interface
- 4 - Ventilation valve

1. Power port and Communication port

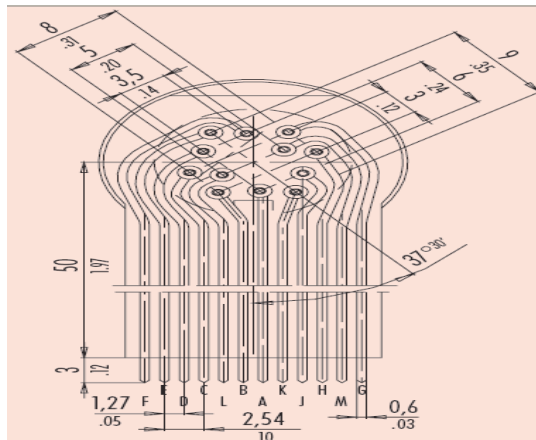

Figure 2-2 Power and communication port air seat number schematic

Air outlet signals are defined in Table 2-1:

Table 2-1 power supply and communication port signal function

Letter	Signal description	Definition
A	Network cable port PIN-J3	ETN_RX+
B	Network cable portport PIN-J6	ETN_RX-
C	Ground	GND
D	Ground	GND
E	NC	NC
F	NC	NC
G	Serial transmission signal line TXD (This device sends)	DBG_TX#
H	Serial reception signal line RXD (This device receives)	DBG_RX#
J	Ground	PWR_GND
K	24V power input positive	PWR_VIN
L	Network cable port PIN-J1	ETN_TX+
M	Network cable port PIN-J2	ETN_TX-

2. Standby interface, without electrical characteristics

3. I/O control interface

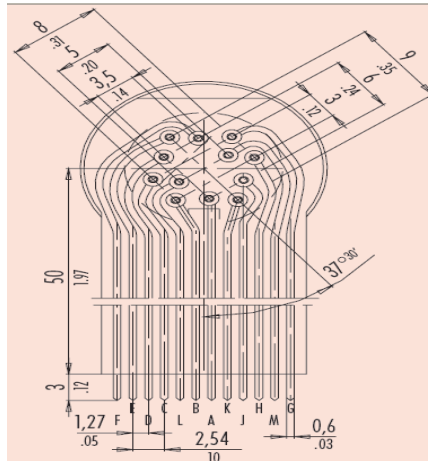

Figure 2-3 I/O control interface schematic

Signals are defined in Table 2-2 or Table 2-3.



If you are using the XC-RF850 reader with relay output, see signals defined in Table 2-2; If you are using the XC-RF850 reader with Wiegand output, see signals defined in Table 2-3.

Table 2-2 I/O control interface signal function definitions (for XC-RF850 FCJ / FLJ)

Pin	Signal definition	Remark
A	Optocoupler input 1 positive	Drive voltage: DC 5V - 12V Drive current: 20mA
B	Optocoupler input 1 negative	0V
C	Optocoupler input 2 positive	Drive voltage: DC 5V - 12V Drive current: 20mA
D	Optocoupler input 2 negative	0V
E	Relay output channel 1-1	Contact voltage / current: 30VDC/1000mA or 125VAC /500mA
F	Relay output channel 1-2	
G	Relay output channel 2-1	Contact voltage / current: 30VDC/1000mA or 125VAC /500mA
H	Relay output channel 2-2	
J	Relay output channel 3-1	Contact voltage / current: 30VDC/1000mA or 125VAC /500mA
K	Relay output channel 3-2	
L	GND	5V output with maximum output current 100mA. Do not power an external device. Internal input trigger only.
M	5V	

Table 2-3 I/O control interface signal function definitions (for XC-RF850 FCW/FLW)

Pin	Signal definition	Remark
A	Optocoupler input 1 positive	Drive voltage: DC 5V ~12V Drive current: 20mA
B	Optocoupler input 1 negative	0V
C	Optocoupler input 2 positive	Drive voltage: DC 5V ~12V Drive current: 20mA
D	Optocoupler input 2 negative	0V
E	Wiegand 1 Data_0 (WG1_D0)	high level: +5V low level: 0V
F	Wiegand 1 Data_1 (WG1_D1)	high level: +5V low level: 0V
G	Wiegand 1 Ground (GND)	0V
H	Wiegand 2 Data_1 (WG2_D1)	high level: +5V low level: 0V
J	Wiegand 2 Data_0 (WG2_D0)	high level: +5V low level: 0V
K	Wiegand 2 Ground (GND)	0V
L	GND	5V output, maximum output current 100mA. Do not power an external device. Internal input trigger only.
M	5V	

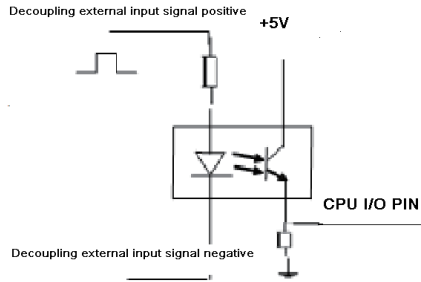

Figure 2-4 Optocoupler input control

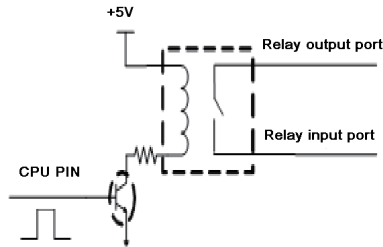

Figure 2-5 Relay output control

4. Ventilation valve without electrical characteristics

2.3.2 RF connector panel

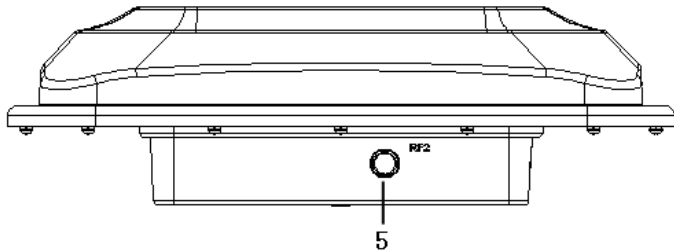

Figure 2-6 XC-RF850 RF interface panel

Interface defined as follows:

5- RF2 RF output port

RF2 port: TNC-RP connector for connecting RF cable

2.3.3 LED display panel



Figure 2-7 XC-RF850 reader display panel

The definitions for LED indicators are shown in figure 2-3:

Table 2-3 Definition of LED panel indicators

Label	Name	Status description
ANT1	Antenna 1 indicator	ANT1 led light indicates antenna 1 is working, green light indicates this antenna has not received tag data, red light indicates this antenna has received tag data
ANT2	Antenna 2 indicator	ANT2 led light indicates antenna 2 is working, green light indicates this antenna has not received tag data, red light indicates this antenna has received tag data
PWR	Power/Operating status indicator	During power on, green light indicates the reader has power supply, blinking red light indicates the system has completed initialization and enters into normal operating condition

2.4 Commissioning preparation

It is mentioned previously that a complete RFID data collection system is consisted of reader, electronic tag, antenna, PC system, and reader interface software. The detailed descriptions of the specific requirements for each component are as follows:

2.4.1 Personal computer Require

- CPU: Pentium 4, Clock speed: 2.8G and above
- Internal storage: 512M Byte and above
- Hard disk: 500G and above
- Communication port: 9 pins RS-232, and RJ-45 network port (10/100M)
- Operating system: Windows 2000(SP3), Windows Server 2003, Windows XP(SP2), Windows 7, and Windows 8

2.4.2 Reader interface software

- RFID reader universal presentation software
- .NET API, VC and JAVA dynamic link library



For detailed description refer to RFID Reader API Technical Reference Manual and RFID Reader Demo Software User Manual.

2.4.3 External antenna

The XC-RF850 has a built-in antenna. We recommend Invengo's XC-AF11-A and XC-AF12-A antenna for two antennas application. The XC-AF11-A is a linearly polarized antenna and the XC-AF12-A is a circularly polarized antenna.

The performance specifications of XC-AF11-A are as follows:

- Frequency range: 840MHz ~868MHz, 902MHz ~928MHz
- Voltage Standing Wave Ratio: $\leq 1.4: 1$
- Gain: $> 7.15\text{dBi}$
- HPBW (H-plane): 60°
- HPBW (E-plane): 70°
- Polarization: Linear polarization
- Relative humidity: 5% ~95%RH

- Input impedance: 50Ω
- Connector type: N-type RF coaxial connector
- Dimension: 291mm×291mm×52mm
- Weight: 0.91kg (Exclusive of bracket)
- Material: Plastic ASA, aluminum
- Color: White
- Protection: IP65
- Operating temperature: -40°C ~+ 70°C

The performance specifications of XC-AF12-A are as follows:

- Frequency range: 840MHz ~930MHz
- Voltage Standing Wave Ratio: ≤1.3: 1
- Gain: >7.15dBi
- HPBW (H-plane): 60°
- HPBW (E-plane): 60°
- Polarization: Circular polarization
- Relative humidity: 5% ~95%RH
- Input impedance: 50Ω
- Connector type: N-type RF coaxial connector
- Dimension: 291mm×291mm×52mm
- Weight: 0.88kg (Exclusive of bracket)
- Material: Plastic ASA, aluminum
- Color: White
- Protection: IP65
- Operating temperature: -40°C ~+ 70°C

We also provide more options for you allowing XC-RF850 reader to work with your existing antenna which fulfills the following requirements:

- Input impedance: 50Ω
- Gain: 7.15dBi
- Voltage Standing Wave Ratio: ≤1.4: 1
- Frequency range: 902.75MHz to 927.25MHz

2.5 Safety during installation

In order to ensure your personal safety and the safety of your belongings, please make the following preparations before the installation of XC-RF850 reader.



Check if the ground terminal of power outlet has been connected to the ground, and check if the local power supply voltage is compatible with the reader's voltage range!



Ensure the grounding of the equipment metal casing. Use InvenGo "grounding wire Φ 4.2 (double) _18AWG_ green yellow_1.5m" cable. The internal material code of the grounding cable is 2200500034.



Measure and estimate the distance between the equipment and the system (for example reader and antenna, reader and PC, reader and power outlet);



Check if the location and direction of reader and antenna will generate signal interference to the information exchange between the reader and the electronic tag;



Take note of the choice and length limitation of the serial cable;



Install and use the reader after only status testing;



During the installation of multiple readers or a high concentration of readers, take note of the antenna positioning and minimum distance between each antenna to avoid mutual interference

2.5.1 External RF cable

RF cable requirement:

RP-TNC (male) connects to the connection port in the reader, while the N-JAY (male) connects to the connection port in the antenna. The recommended RF cable is RF cable RP.

TNC-4(male)_KSR240_N-J4Y(male)_6m, input impedance 50Ω and line losses of less than 2dB.

The internal material code for the RF cable is 2200800009.



Excessively long RD cable will lead to attenuation of RF transmitting signal and receiving signal, resulting in deterioration of read and write performance.

2.5.2 Power and communication interface cable

Cable Specifications:

- 12 core
- with metal shielding
- outer diameter of 8.8mm
- black insulating sheath
- main cable length of 0.1m, each branch cable length is 4.9m

As shown in Figure 2-8, "Aviation plug" is connected to "Power and Communication Interface" on the XC-RF850 reader, and 12 core main cable provides the three different signals, such as "DB9 serial cable. DC power cable and RJ45 Ethernet port connector cable ", mainly used for power supply and data transmission.

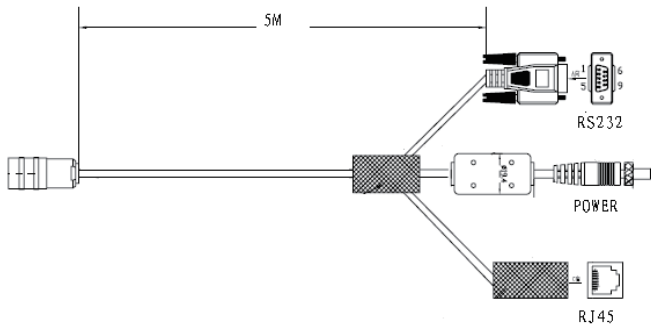

Figure 2-8 Power supply and communication cable

(1) DB9 serial port contains RS232 serial signal and RS485 signal. Specific signals are defined as follows in Table 2-5:

Table 2-5 I/O port cable

No.	Pin number	Signal definition
1	Pin-1	NC
2	Pin-2	RXD
3	Pin-3	TXD
4	Pin-4	NC
5	Pin-5	GND
6	Pin-6	NC
7	Pin-7	GND
8	Pin-8	NC
9	Pin-9	NC



Use RS232 serial port to directly connect DB9 serial cable to the PC serial port.

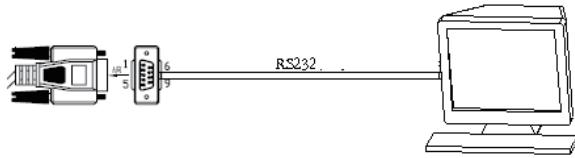

Figure 2-9 RS232 connection

(2) The power connector can be connected with Invengo standard power adapter (DC24V/2.5A output), and tightened with nuts.

(3) The network port is used for long distance high speed connection (not more than 70 m), and the network interfaces can be connected to a switch or router with wiring, and can also be directly connected to the PC network port. The specific connection is shown in Figure 2-11:

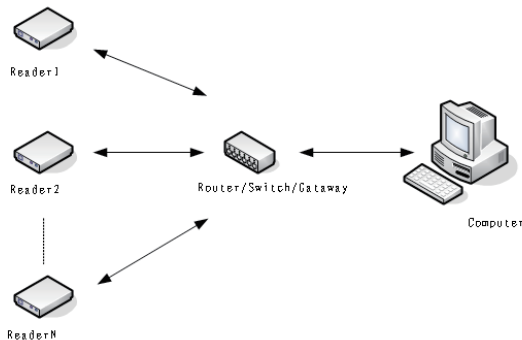
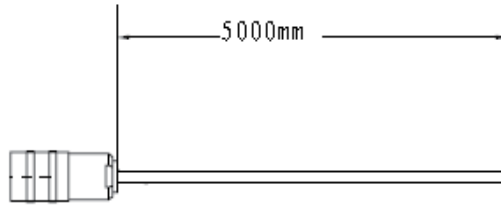

Figure 2-10 Ethernet connection

2.5.3 I/O control port cable

- Cable specifications:
- 12-core
- metal shielding mesh
- Outside diameter 8.8mm
- black insulated jacket
- cable length of 5M

As shown in Figure 2-12, the “plug” is connected to XC-RF850 reader’s “I/O control port”. 12-core cable provides two Optocoupler input ports and three relay out ports or two Wiegand output ports. These interfaces are used for input triggering, and controlling reader peripherals switches or uploading acquired information.



(1)

Figure 2-11 I/O port cable



User can differentiate the functions according to colors of line. The definitions are as follows. For relay out see Table 2-6 or for Wiegand features see Table 2-7.

Table 2-6 I/O port cable (for XC-RF850 FCJ/FLJ)

Colour	Port	Electrical properties
Orange	Optocoupler input 1 positive	Drive voltage: DC 5V ~12V Drive current: 20mA
Yellow	Optocoupler input 1 negative	Negative or ground
White	Optocoupler input 2 positive	Drive voltage: DC 5V ~12V Drive current: 20mA
Gray	Optocoupler input 2 negative	Negative or ground
Red	Relay output channel 1-1	Contact voltage/current: 30VDC /1000mA or 125VAC 500mA
Pink	Relay output channel 1-2	
Light green	Relay output channel 2-1	Contact voltage/current: 30VDC /1000mA or 125VAC 500mA
Black	Relay output channel 2-2	
Blue	Relay output channel 3-1	Contact voltage/current: 30VDC /1000mA or 125VAC 500mA
Brown	Relay output channel 3-2	
Purple	GND	5V output with maximum output current 100mA. Do not power an external device. Internal input trigger only.
Green	5V	

Table 2-7 I/O port cable wiring instructions (for XC-RF850 FCW/FLW)

Colour	Port	Electrical properties
Orange	Optocoupler input 1 positive	Drive voltage: DC 5V ~12V Drive current: 20mA
Yellow	Optocoupler input 1 negative	Negative or ground
White	Optocoupler input 2 positive	Drive voltage: DC 5V ~12V Drive current: 20mA
Gray	Optocoupler input 2 negative	Negative or ground
Red	Wiegand 1 Data_0	WG1_D0(high level: +5V,low level: 0V)
Pink	Wiegand 1 Data_1	WG1_D1(high level: +5V, low level: 0V)
Light green	Wiegand 1 GND	GND(0V)
Blue	Wiegand 2 Data_0	WG2_D0(high level: +5V, low level: 0V)
Black	Wiegand 2 Data_1	WG2_D1(high level: +5V, low level: 0V)
Brown	Wiegand 2 GND	GND(0V)
Purple	GND	5V output with maximum output current 100mA. Do not power an external device. Internal input trigger only.
Green	5V	

2.6 Equipment installation

- **Wall-mounting**

Installation step one: use the adjustable mounting brackets as shown in Figure 2-13 with four M5*8mm screws to fasten the XC-RF850. As shown in Figure 2-13:

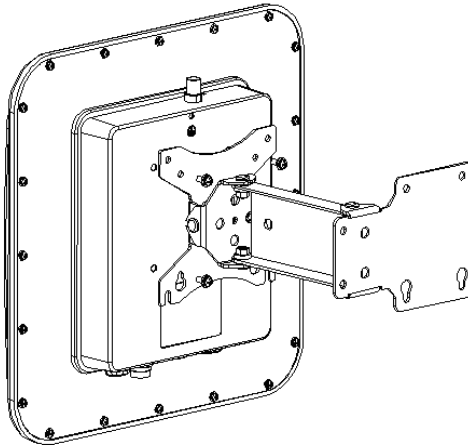

Figure 2-12 Wall-mounting

Installation step two: as shown in the following figure, drill the holes on the mounting wall, hit the expanding nuts into the holes, and then screw the adjustable mounting brackets to the wall.

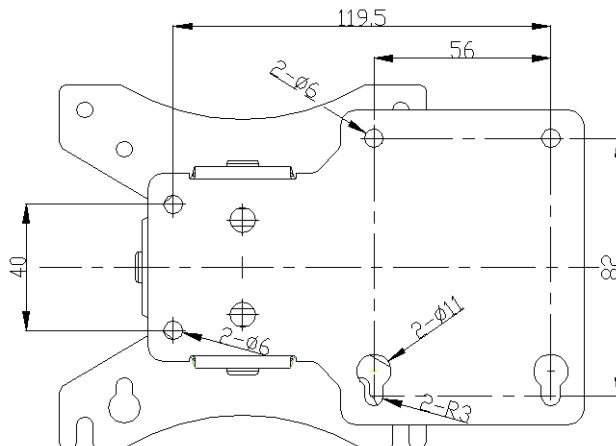

Figure 2-13 Screw positions

Installation step three: for installation in small space, in order to prevent misread, install antenna shield plate, shown in the following figure. Screw four separate shielding plates as shown in figure below. Screw mounting brackets to the mounting wall with 4 M5*8mm screws.

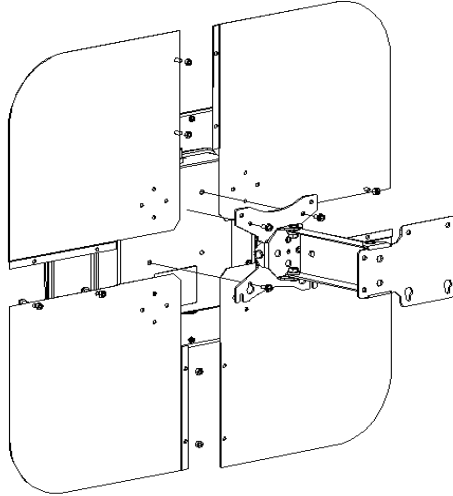

Figure 2-14 Antenna shield plate installation

- **Vertical mounting**

Installation step one: screw the L-shaped mounting bracket with 4 M5*8mm screw.

Installation step two: fasten the L-shaped mounting bracket bracket on the vertical rod with two u-bolts and two tooth-shaped bracelets as shown in following figure.

Note: this installation method is suitable for installation on a vertical Rod of diameter 50mm - 80mm.

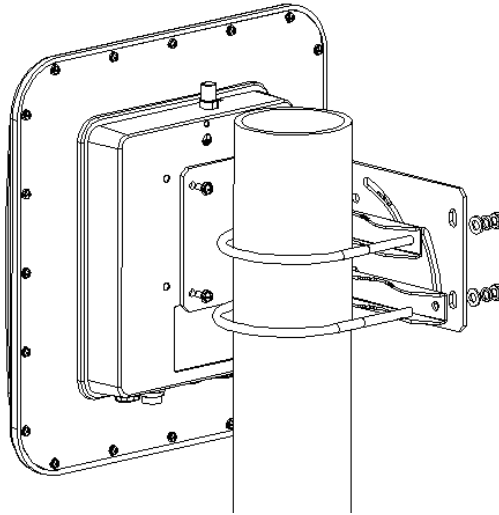

Figure 2-15 Vertical mounting

- **Transverse mounting**

Installation step one: fasten the L-shaped mounting bracket with four M5*8mm screws.

Installation step two: fasten the L-shaped mounting bracket on the rod with two u-bolts and two tooth-shaped bracelets as shown below.

Note: this installation method is suitable for installation on a rod of a diameter of 50mm - 80mm.

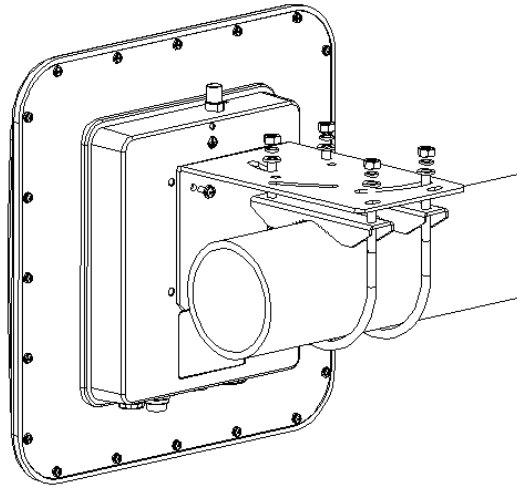

Figure 2-16 Transverse mounting

- **Peripherals installation**











Step 1: Connect RF cable. XC-RF850 provides four RF connectors for antenna connection. Try to use low-loss RF cable for the connection. The cable connection at the reader port and the antenna should be tightened.

Step 2: Install external antenna. XC-RF850 external antenna (RF2) is normally installed outdoor. Its beam coverage is essentially the effective range of the tag reading and writing system. In accordance with the on-site specific requirement, the equipment's external antenna can be installed horizontally (at the gantry of vehicle pass way) or vertically (mounted on a rod). Antenna(s) can be adjusted to the perfect position through tests.

Step 3: connect to PC or switch. The XC-RF850 is delivered with a 5m long power communication interface cable. Users can use this cable to connect the reader directly to your computer.

Step 4: Connect to the power supply. The reader is powered through power adapter. The power outlet of the reader is an AC adapter with positive terminal inside and negative terminal outside. Please take note of the positive and negative terminal while connecting to a power adapter. Once connected to power supply, the "PWR" indicator of the LED panel will light up and the Linux operation system of the reader will initialize. Wait for approximately 15 seconds. Once the reader releases a "di-di" sound, the system has completed its initialization and enters into standby mode. Now, the reader is ready for normal operation.

● **Note:**

-  XC-RF850 reader enters standby mode by default after initialization. The reader does not transmit any frequency during initialization and under standby mode (RF amplifier is turned off). RF amplifier only enters into operating condition after being connected to the antenna or current load and received “read or write tag command” or “start amplifier” command from the PC.
-  The RF cable connectors of the reader must be tightened, otherwise the tag reading distance and tag written success rate will be directly impacted;
-  This reader is not suitable to be used in unstable environment, such as during the transportation process;
-  The reader should be installed in sheltered and well-ventilated places, protected from the rain, humidity and the sun (not suitable for places with high humidity);
-  Measure and estimate the distance between the equipment and the system (for example the reader and the antenna, the reader and the PC, the reader and the power outlet);
-  Check if the location and direction of the reader and the antenna will generate signal interference to the information exchange between the reader and the electronic tag;
-  Take note of the choice and length limitation of the serial cable (serial cable < 10m, network cable < 70m);
-  During the installation of multiple readers or a high concentration of readers, take note of the antenna positioning and minimum distance between each antenna to avoid mutual interference;
-  When connected to DC, avoid reversing the positive and negative terminal as well as open circuit.
-  Avoid supplying the reader with DC higher than 30V.
-  Avoid connecting 5V output (green wire) directly to any other output ports or the reader’s metal body, which might cause irreversible damage to internal circuits.

2.7 Common scenario during commissioning

The section details the common scenario during commissioning, with special focus on the general issues that appear during incorrect installation, and provides solutions to these scenarios.

Main issues during commissioning:

- **Unresponsive reader**

- Power supply indicator status → Check the power cable connection and inspect the corresponding items under the indicator status inspection;
- Network communication condition → Check if the connection IP is correct, check also if IP address is in conflict;
- Check serial port → check if the setting for port and the communication rate of the application software correct;
- Check if the setting for antenna signal is correct

- **Tag reading/writing error**

- Check if the reader configuration in the application software is correct;
- Check if the reader and tag are compatible with one another;
- Check the tag position whether the tag is located within the effective reading range of the reader;
- Check if there is any electromagnetic interference between the readers or other devices;
- Check if the tag requires access password and if the password is correct;
- Check if the tag is damaged;

- **Unsatisfactory reading/writing range**

- The positioning of antenna installation;
- Interferences from the surrounding.

2.8 Inspection and acceptance

Inspection is conducted mainly on two aspects: Structure and performance

1) Structural inspection

Check if the installation fulfills safety standards and if all the equipment can function normally.

- if the reader is firmly fixed.
- if all cables are securely connected.
- if the bolts are tightened.

Please refer to installation requirements.

2) Performance acceptance

Normal performance of the reader is inspected from two aspects:

- check if the reader is functioning properly;
- check if the reading/writing range fulfills the requirement.

3 DEMO user guide

3.1 Preparation and examination

Demo software mainly is mainly used to perform system control, parameter setting, parameter queries, communication mode selection and RF tag reading, writing and display on the reader. The CD-ROM which comes with shipment contains .NET version of demo software and .NET version API, JAVA API and C++ API for users to use during secondary development.

3.2 Demo software

- RFID Demo V1.2.2 and above

3.2.1 Demo software installation

Note: This section introduces the installation and application on Windows version software.

STEP ONE:



Double click setup document [setup.exe](#). If the system is not preinstalled with .NET Framework 2.0, the system will automatically prompt the user to install .NET Framework 2.0, as shown in the figure below:

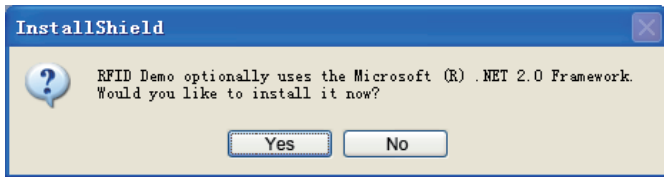

Figure 3-1

Click on “Yes” to install .NET Framework 2.0:

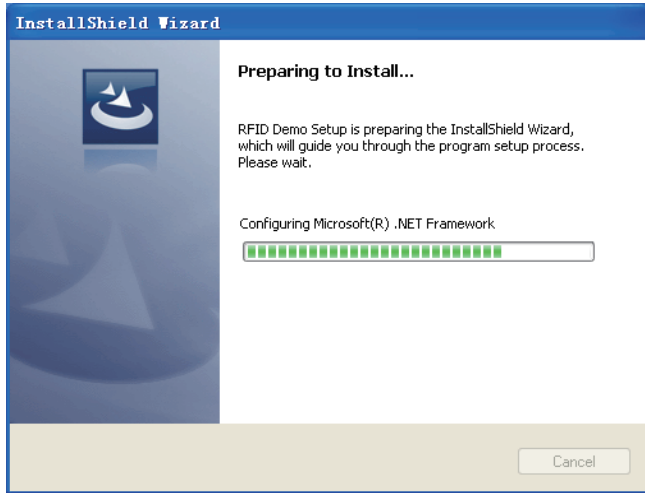

Figure 3-2

STEP TWO:

Upon the completion of installation process, the screen will enter into Choose Setup Language interface as shown in the figure below (if the system has been pre-installed with .NET Framework 2.0, the screen will enter directly to the Choose Setup Language interface), as shown below:

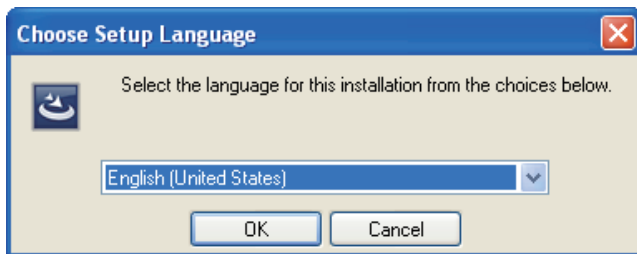

Figure 3-3

Select the setup language, Mandarin and English are both available.

Here, English is used as an example, click OK. The system starts to unzip folders and this process requires several seconds. Upon completion, the screen will enter into the following interface:

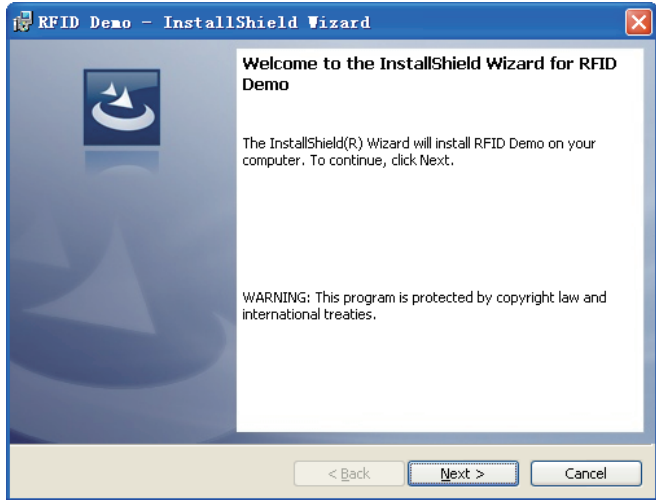

Figure 3-4

STEP THREE: Click on "Next":

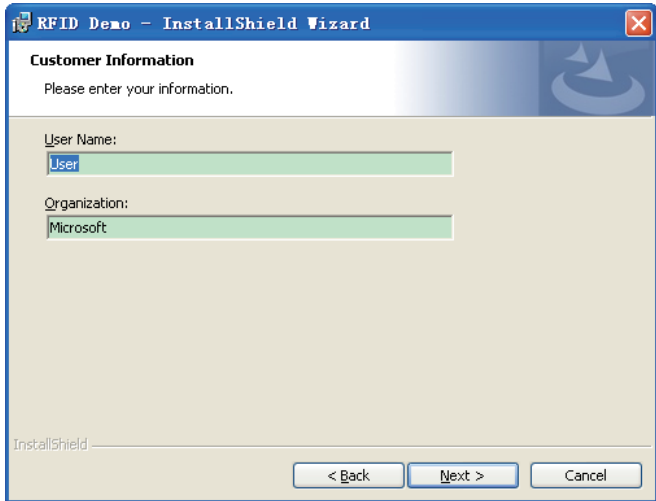

Figure 3-5

Enter user name and organization,

STEP FOUR: Click on "Next":

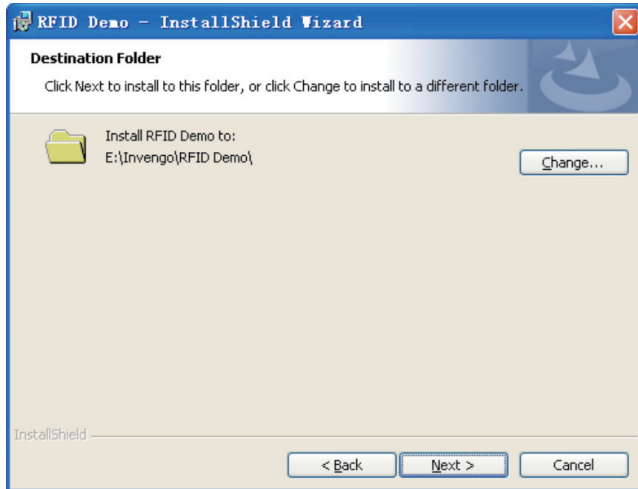

Figure 3-6

Select the destination folder for the program. The default selection is: “E:\Invengo\RFID Demo\”. If there is a need to change, please click on “Change...” to customize and then click on “Next”:

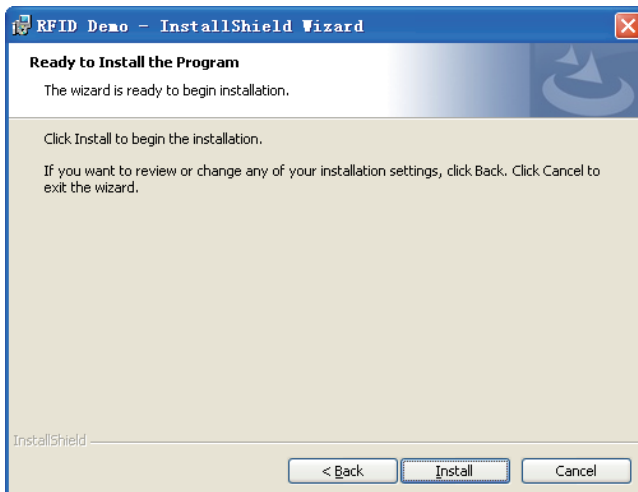

Figure 3-7

STEP 5: Click on “Install”:

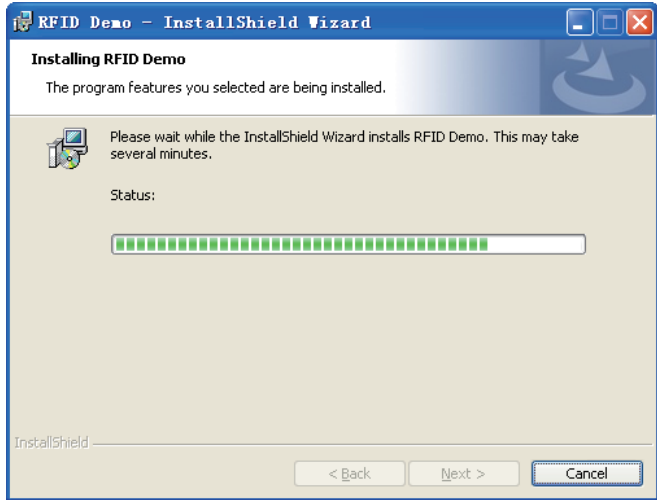

Figure 3-8

Installing...below shows the screen upon completion:

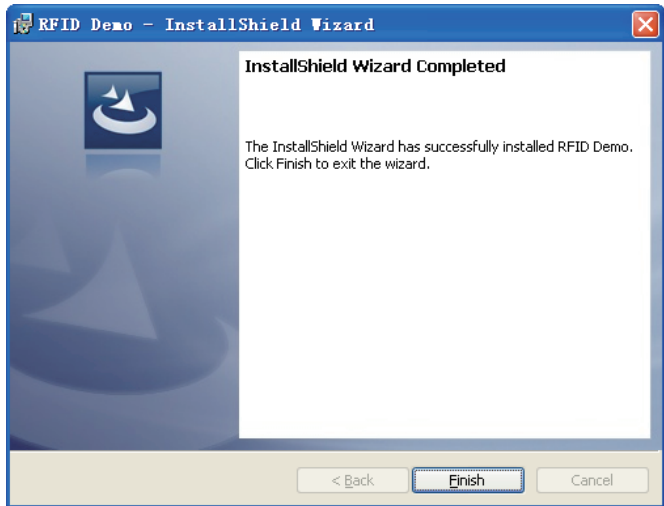

Figure 3-9

STEP 6: Click on “Finish” to complete the software installation. There will be a “RFID Demo” shortcut appeared on the desktop.

3.3 Demo software operation

3.3.1 Demo initialization

During initial running Demo, the default mode is single reader mode. The connected device operation is located on the central left of the main interface, as shown in the figure below:

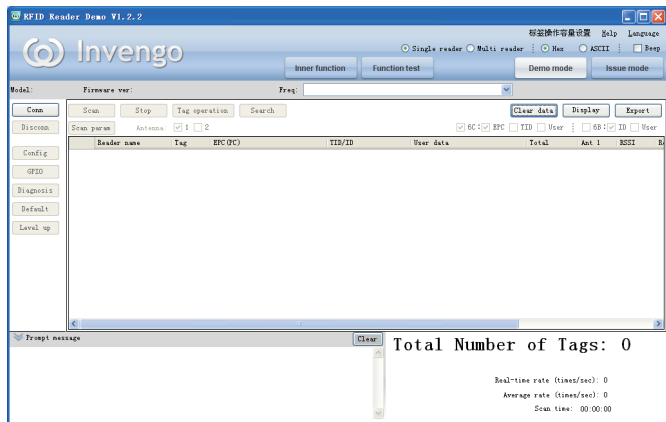

Figure 3-10

3.3.2 Connection

Click on “Conn” button as shown in the figure below:

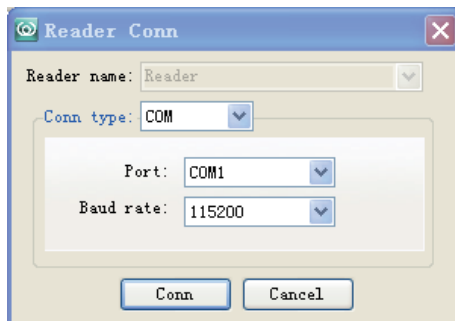

Figure 3-11

Please select connection method based on the actual scenario:

TCP/IP client (Network)

RS-232 (Serial)

Enter the control reader IP and port no. and click on “Conn.” Failure to connect will be prompted.



Figure 3-12

If the connection is successful, the interface will disappear and the screen will return to the single reader interface. Successful connection will be indicated on the bottom left corner.

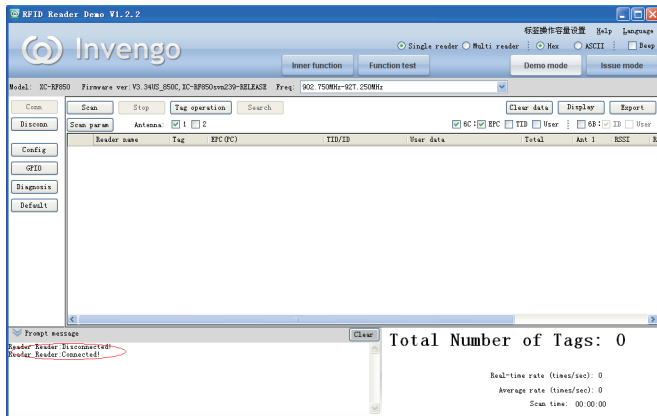

Figure 3-13

After successful connection, if there is a need to disconnect, click on “Disconnect”.

3.3.3 Reader configuration

To configure the reader, click on the reader configuration button, and a dialog box will pop up. Set up the reader's IP address, baud rate and related information configuration of RFID, as shown in the figure below:

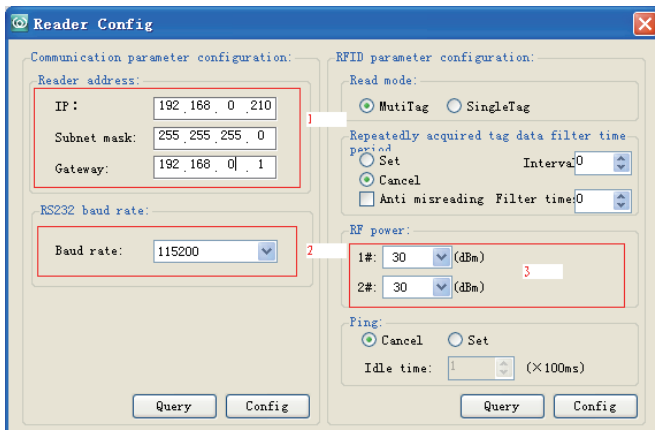

Figure 3-14

After completing configuration, click on “Config” to save the configuration. Click on “Query” to inquire about the current configuration of all connected readers.

Reader address-1: Refers to the configured network parameters based on actual needs (connecting reader in the same network segment)

Baud rate-2: Refers to the configured serial communication baud rate based on actual needs.

RF port power-3: Refers to the configured RF port power based on actual needs. Normally, the larger the power, the longer is the reading range.

Reading mode: SingleTag, suitable for the quick reading of single tag, in the case of one tag within a RF antenna field; MultiTag, suitable for the simultaneous reading of multiple tags within a field of RF antenna field

Smart hibernation mode: The reader will enter into hibernation after being idle for a period of time. The hibernation duration refers to the idle time in the configuration. Otherwise, click on “Cancel” if no such configuration is needed.

3.3.4 Antenna choice

This reader has 2-channel antenna and these antenna can be formed random combinations as shown in the figure below:



Figure 3-15

3.3.5 Scanning configuration

Scanning parameter setting as shown in the figure below:

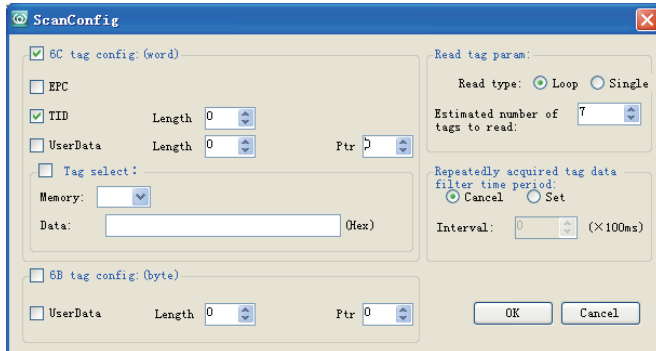

Figure 3-16

6C tag reading configuration: Select the required 6C tag fields, including EPC, TID, UserData

Tag reading parameter: Select reading method, available in loop reading and single reading

Repeatedly acquired tag data filter time period: Similar tag upload time, configuration and query

Tag operation

After configuring the reader as with 3.3.3 and 3.3.4 and 3.3.5, select the corresponding tag type (6C tag), then click on “Scan” to scan the tag, as shown in the figure below:

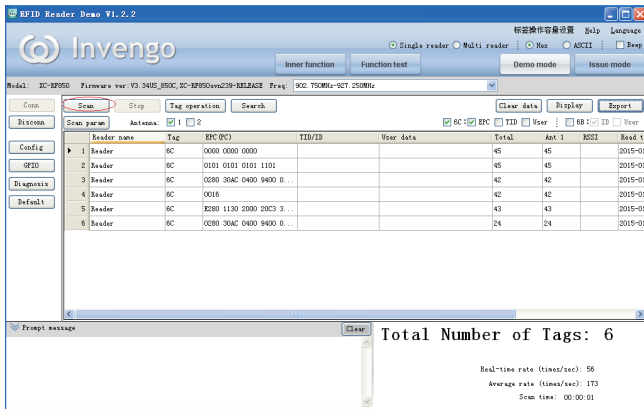

Figure 3-17

3.3.6 Tag operation

To perform EPC or user data area reading and writing operation on specific tag, enter tag reading and writing interface (click on “Scan” → select scanned tag → click on “Tag operation”). Main operations includes write EPC_6C, read user data_6C, write user data_6C, block operation_6C, as shown in the figure below:

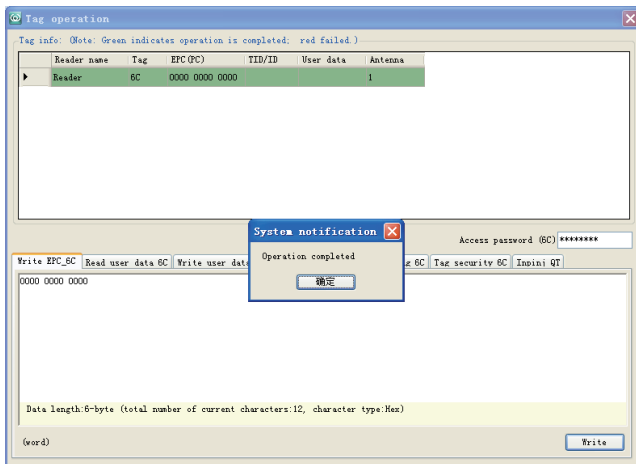

Figure 3-18

3.3.8 GPIO

Configure the reader I/O output port signal and the tag reading trigger condition as well as the termination of tag reading trigger condition, as shown in the figure below:

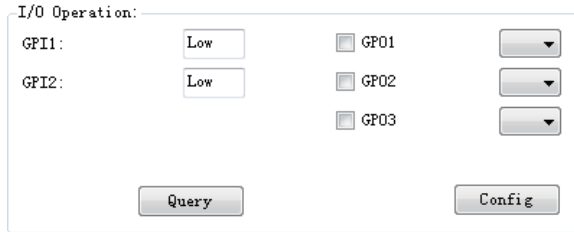

Figure 3-19

Query: Inquire on the status of all input ports.

Config: Tick on the desired output ports to make modification before clicking on “Config” to save the configuration.

I/O trigger allows the reader to be trigger based on different status of I/O port, as shown in the figure below:

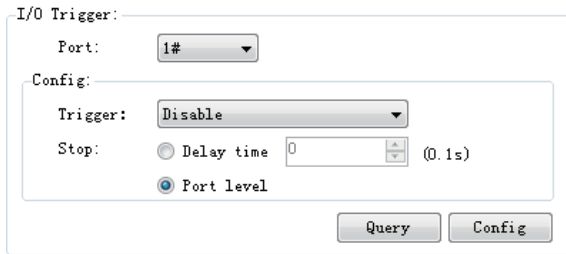

Figure 3-20

Tag reading I/O trigger configuration:

Trigger port: Select the trigger port. There are two options available:

- 1#
- 2#

Query: Inquire on the configuration of selected input port.

Config: Configure the trigger configuration of the selected input port.

Trigger condition: Available options shown below:

Close (turn off trigger condition)

Falling edge (level changes from high to low)

Rising edge trigger (level changes from low to high)

High level trigger (high steady state)

Low level trigger (low steady state)

Termination condition: Available in delay timing and port level.

Delay timing: Configure the continuous operating duration and cause the reader to stop automatically once time runs up. Unit: 0.1 second.

Port level: Automatically select condition that contradicts the trigger condition.

Detailed explanation: I/O trigger is an automated tag reading function that is based on I/O trigger condition and transfers the tag data to the host PC. There are two trigger ports that can be configured independently. The tag reading configuration is similar to the current reader scanning configuration.

Note: When configuring tag reading trigger, first configure the scanning configuration. Click on the scanning configuration, same as the setting in 3.4.5, then configure the trigger port, trigger condition and termination condition.

3.3.9 Operation mode

This section provides the option to modify the operation mode. depending on the work environment or operation requirements, select the desired mode.

Select the “Multiple readers -> Advanced configuration → Mode” (without this, it says the reader does not support this feature). It appears:

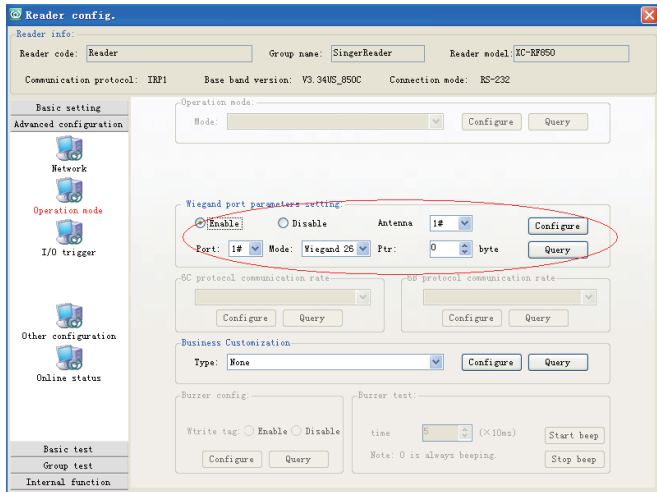

Figure 3-21

Screen appears. It automatically queries the current mode.

Wigan port parameter setting including: “Enable” and “Disable”, “Antenna”. “Port”. “Type” and “Configure”

Antenna numbers include: 1# and 2#

Port numbers include: 1# and 2#

Type options include:

1. Wiegand 26: the first 3 bytes of TID data reported from Wiegand port are valid, and the last 5 bytes are zero.
 2. Wigan 34: the first 4 bytes of TID data reported from Wiegand port are valid, and the last 4 bytes are zero.
 3. Wigan 66: the first 8 bytes of TID data reported from Wiegand port are valid.
- Configure: acquire the start byte location of of data, 0 do not acquire.

3.3.10 Version Enquiry

Inquire the reader model and firmware version through RFID DEMO software, as shown in the figure below:

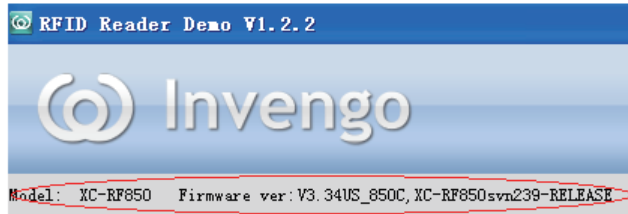

Figure3-22

The definition of each information is as follows (this is just an example, subject to changes with version upgrade):

Mode: XC-RF850 reader

Firmware version:

V3.34US_850C (RFID processor software version)

XC-RF850SVN239-RELEASE (Application processor software version)



Figure 3-23

V1.2.2 is the version of RFID DEMO software, as shown in figure 6-2

Explanation:

- For detailed introduction on the DEMO software operation, please refer to “RFID Demo Software User Manual”.

4 Routine maintenance and service

4.1 Routine maintenance

- Check if the connection of the RF connector is good.
- Check if the connection of fixed reader and antenna is good.
- Check if the external shield layer of RF cable joint is good.
- Check if the connection of reader power cord is good.

4.2 Troubleshooting and solution

During the application of XC-RF850 reader, users may encounter various issues. This section consolidates all common issues during application and their solutions.

1. "Power" indicator does not light up after the power supply has been switched on for 15 seconds

- Check if the power supply from the power adapter is working normally. Check also if the AC power voltage falls between 100V and 240V
- Check if the power cord connection is poor or not properly connected
- Check if the positive and negative terminal has been reversed

2. Unable to connect through Ethernet port

- The default IP address of the reader under factory setting is: 192.168.0.210. If the host PC's IP address is belonged to the same network segment as the reader, for example "192.168.0.XXX", both devices will connect. If the user forgot about the reader's IP address, please look for a reader that is connected to the host PC through RS-232 serial port (or USB serial port), and reconfigure the IP address of the current reader.

3. Unable to connect through serial port

- The baud rate of the reader is 115200bps. Once connected through serial port, the baud rate should be 115200bps.
- Check if the COM port selected in DEMO software DEMO is the COM port of the host PC that is connected to the reader.
- Check if the serial cable connection is proper. Any disconnection or insecure

connection will cause the command from the PC not being transferred to the reader.

4. Unable to read tag

- Check if the serial cable or the network cable is properly connected. Any disconnection or insecure connection will cause the command from the PC not being transferred to the reader.
- Please check if both ends of the RF connector has been tightened. Check also if the tag is damaged.

5. Tag reading and writing error

- Check if the reader configuration in the application software is correct;
- Check if the reader and the tag are compatible;
- Check the tag position whether the tag is located within the effective reading range of the reader;
- Check if there is any electromagnetic interference between the readers and other equipment;
- Check if the tag is damaged.

6. Unsatisfactory reading/writing range

- The positioning of antenna installation;
- Interferences from the surrounding.

7. The reader fails to detect the tag

- Check if the configuration of the antenna is correct. If the antenna is connected to 1# RF port, 1# antenna must be chosen in the DEMO software.
- Check if the tag is compatible with ISO18000-6C protocol. Any tag that is not compatible with ISO18000-6C will not be detected.
- Check if the tag is damaged. If the ID is undetected, please try with a different reader and check if the tag has been damaged. If the data area remains undetected, check if the tag data area has been locked. Locked tag needs to be unlocked.
- Check if the tag is located in the effective reading range of the reader.
- Check if there is any electromagnetic interference between the readers or other equipment.

8. Short tag reading distance

- Check if the reader frequency setting is correct. If the antenna operating frequency range is 902.75MHz - 927.25MHz, the hopping point selected for the

reader should not exceed the antenna's operating frequency range (902.75MHz - 927.25MHz). Otherwise it will affect the performance of the reader.

- Check if the RF output power is low. The RF output power is adjustable.
- Check if the polarization direction of the tag and the antenna is compatible. If the antenna is vertically polarized, the tag must be placed vertically.
- Check if the tag surface is covered with any other materials. If the tag surface is covered with other material, the material may cause deviation in the antenna's frequency and affect the reading effect of the reader. If the material is metallic, the reader will be unable to detect the tag, as RF signal is unable to penetrate metal.
- Check the RF cable connecting the reader and the antenna. If the connector of the RF cable is loosened or broken, RF signal will become very weak and the reading distance will be affected.
- Check the properties of the tag. Metallic tag should be installed at metal surface for the tag to function at full capacity. For other types of tag, please avoid installation near metallic surface.
- Normal aging of tag performance. Due to long term use, the tag performance will decline and result in the shortening of the tag reading distance. However, this will not affect normal usage. Only in the extreme case of aging where the reading distance becomes extremely close and a replacement should be considered.

5 Transportation and storage

5.1 Transport requirements

XC-RF850 meets all the standard requirements of road, rail, air, and water transportations.

5.2 Storage requirements

The long term storage of XC-RF850 must meet the following conditions:

- Ambient temperature: $-30^{\circ}\text{C} \sim +75^{\circ}\text{C}$;
- Relative humidity: 5% \sim 90%RH;
- No abrupt temperature change, with the absence of acidic gas and other harmful gases;

6 Packaging and Inspection

6.1 Packaging

XC-RF850 is packed in a box, and transported through large transport container.

Package size: 655mm×360mm×170mm

6.2 Inspection

In order to facilitate future storage and transport, keep the box and packaging materials during inspection.

Apart from XC-RF861 reader, the package also contains the following accessories, as shown in the table below:

Table 6-1 Accessories List

No.	Item	Quantity	Unit	Order code	Remark
1	Power supply and communication cable XC-RF850	1	Piece	2200700068	Standard
2	External IO cable XC-RF850	1	Piece	2200700067	Standard
3	Output 24V/2.5A power adapter	1	Piece	1080200007	Standard
4	American Standard power line _1.8m	1	Piece	2200500027	Standard
5	RJ45 Network cable_1.5m	1	Piece	2200300003	Standard
6	Cross recessed countersunk head screw Spring washer and flat pad assembly M5 * 10 stainless steel GB9074.4	4	Piece	1500100070	Standard

Holding rod mounting kit

7	L-shaped mounting bracket XC-RF850	1	Piece	2510900091	Standard
8	U-shaped bolt M8x82 XC-RF850	2	Set	1500900028	
9	Tooth shaped mounting bracket XC-RF850	2	Piece	2510900096	

Wall mounting kit

10	Adjustable mounting bracket XC-RF850	1	Piece	2510900092	Optional
11	Flat washerΦ6 stainless steel_GB97.1	4	Piece	1500500028	

Shield plate mounting kit

12	Shield plate_XC-RF850	4	Piece	2510500079	Optional
13	type 1 Hexagon nut M4_ stainless steel_GB6170	8	Piece	1500700015	
14	Cross recessed countersunk head screw Spring washer and flat pad assembly M4 * 10 stainless steel_GB9074.4	8	Piece	1500100013	
15	CD-ROM	1	Piece		Standard
16	Product warranty card	1	Sheet		Standard
17	Product certificate	1	Sheet		Standard



Please check the product and its accessories according to the packing list. Please contact your sales representative immediately if there is any discrepancy or damage.

7 After-sales service

If you encounter any unsolvable problem when using our product, please contact the customer service center.

Before a user engages our customer service center, please prepare the following information at hand:

7.1 Other matters

If our customer service officer has confirmed with the user to return his/her reader for maintenance, the user will receive a return merchandise authorization (RMA) from our customer service officer. Please indicate the RMA no. on the exterior of the return product packaging and, at the same time, provide the same no. on a piece of paper and place it inside the packaging. This will ensure the quick processing of the return product.

Please follow these steps when returning the handheld reader for maintenance:

- Carefully pack the reader and its accessories into the original antistatic foam box. Please use a box with protective effect if the original box no longer exists.
- Use filler to cover the products in the box.
- Place a note, written with RMA no., in the box.
- Indicate RMA no. and the word “fragile” on the exterior of the box.



Singapore:

Invengo Technology Pte. Ltd.

10 Kallang Avenue, # 05-15 Aperia tower 2,
Singapore, 339510

Tel: +65 6702 3909

Email: invengo.sales@invengo.sg

Website: www.invengo.sg

US:

Invengo Technology Corp

2700-160 Sumner Blvd.
Raleigh, NC 27616, USA

Tel: +1 919 890 0202

Toll Free: +1 855 379 2725

Email: sales@invengo.com

Website: www.invengo.com

Shenzhen HQ:

Corporate Headquarters

Invengo Information Technology Co., Ltd.

3/F, No.T2-B, High-tech Industrial Park South,
Shenzhen 518057, China

Tel: +86 800 830 7036

Fax: +86 755 2671 1693

Email: sales@invengo.cn

Website: www.invengo.cn

Europe:

Invengo Technology BV

Belder 30-A, 4704RK Roosendaal,
The Netherlands

Tel: +31 88 6363 793

Fax: +31 88 6363 794

Email: web@invengo.eu

Korea:

Invengo International Pte. Ltd (Korea)

30F ASEM Tower, 517 Yeongdong-daero,
Gangnam-gu, Seoul 135-798 Korea

Tel: +82 2 6001 3525

Fax: +82 2 6001 3003

Email: justin.kou@invengo.sg